



STONIUM

S I M P L E U P G R A D E S





About Us.



If you're a business owner or a homeowner looking to upgrade the interior facilities of your space, then Stonium is exactly what you need to elevate the look and feel of any kitchen or bathroom.

Founded in 2014 by brothers Jad and Charbel Rizk, the company offers a wide variety of high-end, durable, quality products made from US and Russian technologies and materials, in order to keep you up with the latest trend within the right budget.

Team Work

We provide timely delivery for all your needs and a dedicated customer service team for support, along with frequent updates to our products by providing you with the latest carefully-selected designs, each created to meet the needs of your brand or home.

And keeping in line with the latest industry trends, we are always on the lookout for the newest models, colors, designs, and fashion needs to match your very own.

STONIUM

“

We make some tests stand out to emphasize the big point.

Our Concrete

Using Ultra High Performance Concrete (UHPC) in all we produce, Stonium's selection has a very high-density and surpasses all laboratory testing, with very minimal pores that are unlike any other concrete on the market.

Due to years of collective experience, research, and experimentation, Stonium has created a line of products that boast absorption levels nearing zero and ultra-reliability for long-term use.



The Founders.

Meet Charbel Rizk, the ultimate perfectionist, and technical mind behind Stonium's products. With a love for production,

organization, and a total eye for all things involving attention to detail, Charbel never settles for less than absolute perfection.

With a degree in Industrial Engineering from the Lebanese American University (LAU), he went on to study concrete technology in the United States and Russia at two highly esteemed and reputable institutions.

Taking over the family business in the production of natural stone manufacturing since 2009, he used both his experience and knowledge regarding stone and concrete technology to create the Stonium formula.



Charbel Rizk

STONIUM



Jad Rizk

The Founders.

We've met the technical side of the duo with Charbel Rizk, and here we come to the strategic side with his brother, Jad Rizk.

As a business marketing graduate from Notre Dame University (NDU), Jad seeks to find new solutions to everyday problems in the industry.

His many years of experience studying natural stones – and the designs that suit them best – have helped him in matching the right colors and textures to essential daily household products that best suit the needs of not just the market itself, but clients of all kinds.

Along with his brother Charbel, Jad took a leadership role in the family business since 2010 through the managing, marketing, and sales of Stonium, much in part due to his education in Russia regarding concrete trends and technologies.



TOP MOUNT BASINS

Basic Series

Technical Sheets & Projects



The Recta.

Sharp, sleek, and absolutely powerful to look at.
A product that is no-nonsense for those who wish to
add a touch of their own straight-forward personality.

The Recta.



60.5 cm

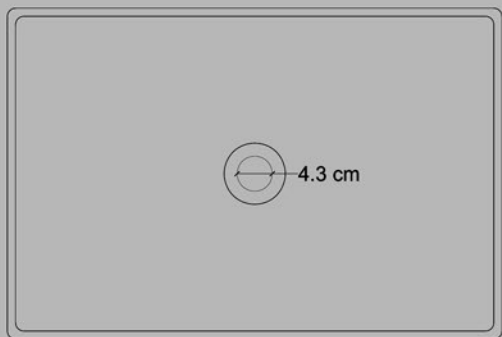

40.5 cm

4.3 cm



12.5 cm



 18 kg

 handmade

 UHPC - Ultra High Performance Concrete

 waterproof

 matte finish

 topmount

 eco friendly

 made in Lebanon

* Concrete casting is a handmade process, therefore a margin of variation can be found from one piece to another in terms of color, leveling, and aggregates dispersion/denseness. The casting process may result in some minor pinholes, light scratches, and color lines that show on the surface of concrete.

STONIUM



“

*When no one else believed in the smoke blue
Recta, we did.*



The Rondo.

The twin brother of Recta, here we see the simpler side of life. This is a wash basin with a more playful side for those who take "laid back" to the next level.

The Rondo.



39.5 cm

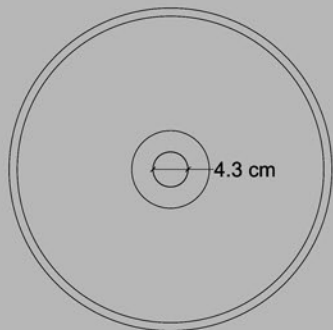

39.5 cm



~11.5 cm~



 13 kg

 handmade

 UHPC - Ultra High Performance Concrete

 waterproof

 matte finish

 topmount

 eco friendly

 made in Lebanon

* Concrete casting is a handmade process, therefore a margin of variation can be found from one piece to another in terms of color, leveling, and aggregates dispersion/denseness. The casting process may result in some minor pinholes, light scratches, and color lines that show on the surface of concrete.

STONUM



“

Small details are vital. Small details make the big picture happen.



The Eggie.

The genius of this basin is its minimalistic simplicity. Perfect for wider bathrooms, but sure to make an impact on the room they reside in with its perfectly rounded smoothness.

The Eggie.



63.5 cm

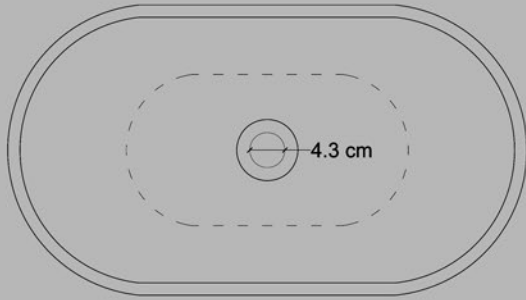

35.5 cm

4.3 cm



15.5 cm



 13 kg

 handmade

 UHPC - Ultra High Performance Concrete

 waterproof

 matte finish

 topmount

 eco friendly

 made in Lebanon

* Concrete casting is a handmade process, therefore a margin of variation can be found from one piece to another in terms of color, leveling, and aggregates dispersion/denseness. The casting process may result in some minor pinholes, light scratches, and color lines that show on the surface of concrete.



“

A private space is not done with thinking, it is with feeling.



The Ellipse.

The picture-perfect example of balance. This model is ideal for perfectionists who seek to find that same balance in their everyday lives.

The Ellipse.

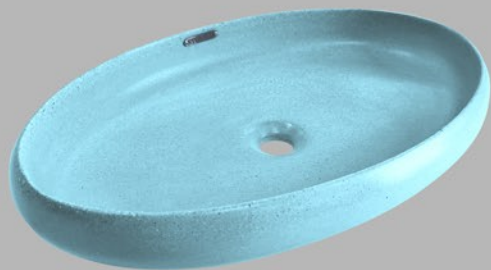

60.0 cm

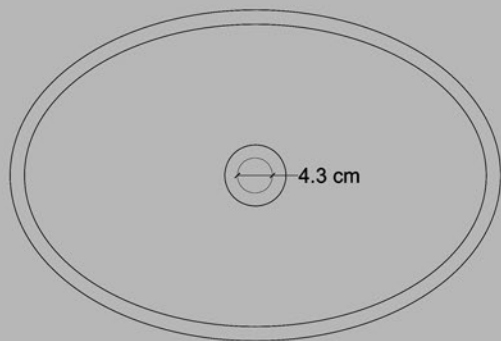

40.5 cm

4.3 cm



12.0 cm



 9 kg

 handmade

 UHPC - Ultra High Performance Concrete

 waterproof

 matte finish

 topmount

 eco friendly

 made in Lebanon

* Concrete casting is a handmade process, therefore a margin of variation can be found from one piece to another in terms of color, leveling, and aggregates dispersion/denseness. The casting process may result in some minor pinholes, light scratches, and color lines that show on the surface of concrete.

STONIUM



“

*Can you question the compatibility of the
Ellipse in this washroom?*



The Minium.

This smaller basin will look grand in a narrowly built bathroom. Our MINIUM is well designed to occupy lesser space and make your bath place look bigger.

The Minium.



41.0 cm

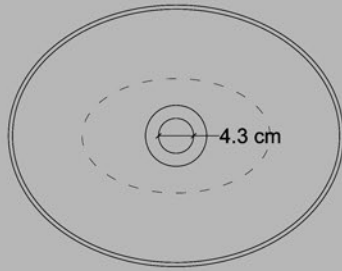

32.0 cm



13.5 cm
14.5 cm



 6 kg

 handmade

 UHPC - Ultra High Performance Concrete

 waterproof

 matte finish

 topmount

 eco friendly

 made in Lebanon

* Concrete casting is a handmade process, therefore a margin of variation can be found from one piece to another in terms of color, leveling, and aggregates dispersion/denseness. The casting process may result in some minor pinholes, light scratches, and color lines that show on the surface of concrete.

MINIMUM



“

A big effect for little Miniums in a narrowly built space.



TOP MOUNT BASINS

Designers' Series

Technical Sheets & Projects



The Gear.

This piece is a paradox with its rugged elegance. For anyone who wishes to add a bit of an edge to something standard as a wash basin, this is the product for them.

The Gear.



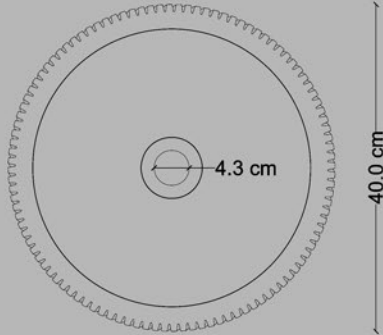

40.0 cm



~10.5 cm



 16 kg

 handmade

 UHPC - Ultra High Performance Concrete

 waterproof

 matte finish

 topmount

 eco friendly

 made in Lebanon

* Concrete casting is a handmade process, therefore a margin of variation can be found from one piece to another in terms of color, leveling, and aggregates dispersion/denseness. The casting process may result in some minor pinholes, light scratches, and color lines that show on the surface of concrete.

“
*If the decor doesn't say it, the Gear
definitely will.*



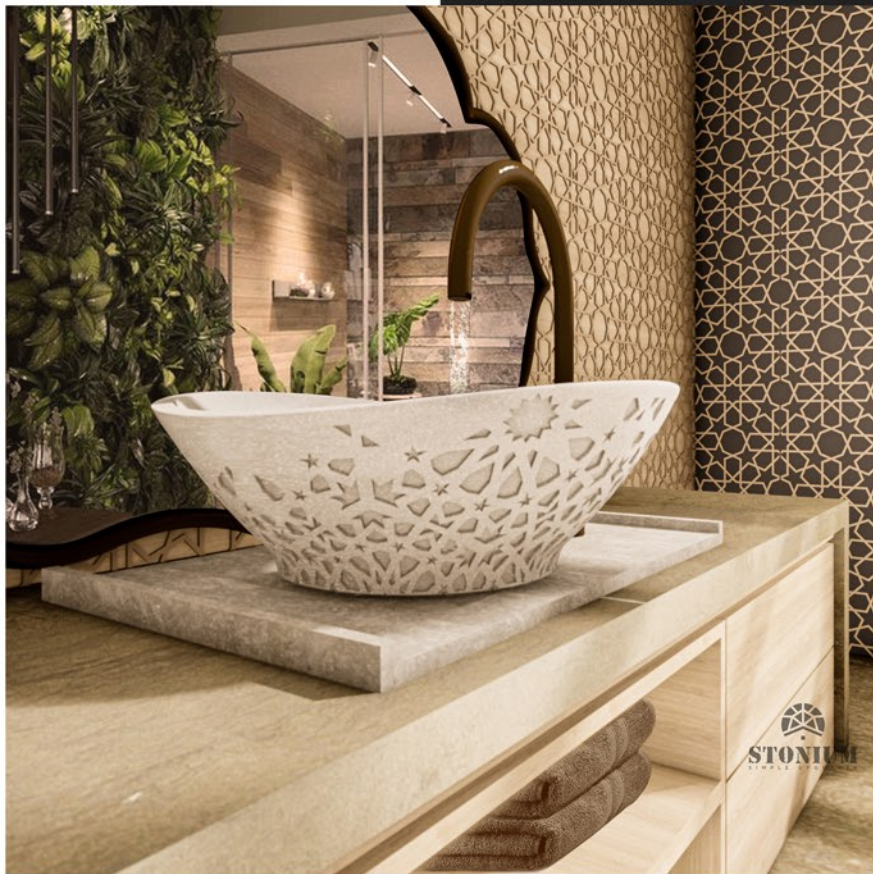

The Arabesk.

Sleek, elegant, and a beautifully designed representation of Arabian nights. Every moment involving this piece will evoke sensations of romanticism and splendor.

The Arabesk.



42.5 cm

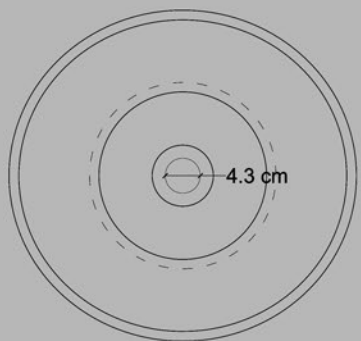

4.3 cm

40.5 cm

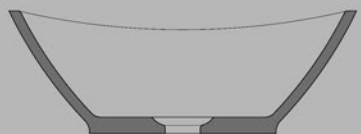

12.7 cm

15.0 cm



 10 kg

 handmade

 UHPC - Ultra High Performance Concrete

 waterproof

 matte finish

 topmount

 eco friendly

 made in Lebanon

* Concrete casting is a handmade process, therefore a margin of variation can be found from one piece to another in terms of color, leveling, and aggregates dispersion/denseness. The casting process may result in some minor pinholes, light scratches, and color lines that show on the surface of concrete.

STONIUM

“

The Arabesk is so confident here, even when colliding with modern interior.



UNDER MOUNT

Single Series

Technical Sheets & Projects



The Oysters L & S.

Say goodbye to boring white undermount basins and hello to endless design possibilities with STONIUM's unique concrete washbasin. Featuring an undermount design and customizable with any color from our extensive palette, this basin is the perfect addition to any modern bathroom.

The Oyster L.



56.0 cm

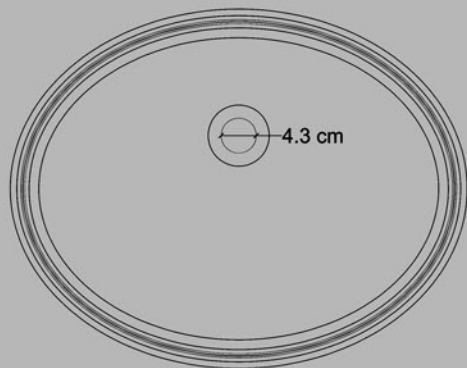

44.0 cm



16.0 cm



 10 kg

 handmade

 UHPC - Ultra High Performance Concrete

 waterproof

 matte finish

 undermount

 eco friendly

 made in Lebanon

* Concrete casting is a handmade process, therefore a margin of variation can be found from one piece to another in terms of color, leveling, and aggregates dispersion/denseness. The casting process may result in some minor pinholes, light scratches, and color lines that show on the surface of concrete.

The Oyster S.



47.5 cm

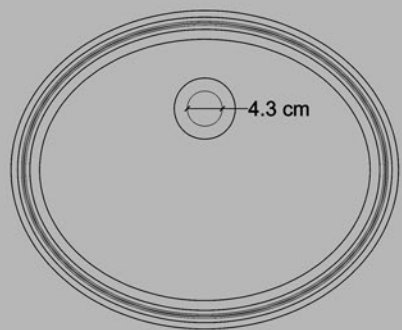

39.0 cm



15.0 cm



 6 kg

 handmade

 UHPC - Ultra High Performance Concrete

 waterproof

 matte finish

 undermount

 eco friendly

 made in Lebanon

* Concrete casting is a handmade process, therefore a margin of variation can be found from one piece to another in terms of color, leveling, and aggregates dispersion/denseness. The casting process may result in some minor pinholes, light scratches, and color lines that show on the surface of concrete.



“

*With the undermount concrete basins from Stonium,
immerse yourself in serenity.*

STONIUM

COLOR PALETTE.

All the colors in the palette are integral within the concrete mix, and we will always be releasing new colors. Subscribe to our newsletter to stay updated with our latest additions.



Earthtone
Series



Pastel
Series



Terrazzo
Series

Earthtone Series

Black WD



D Grey WD

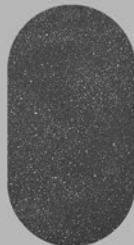

Grey WD

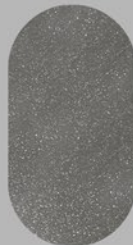

Brown WD



Beige BD



White



Pastel Series

Peach



Banane



Mint



Smoke Blue



Azul



Flamingo



Terracotta

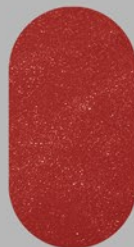

Terrazzo Series

Terra White



Terra Black



STONIUM

BASIN DRAINS.

Unlike all other drains on the market, the stonium pop-up drain can be a perfect match to your washbasin, and lifts it to another level of classness and finesse.



Earthtone Drains

Black WD

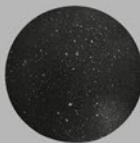

D Grey WD

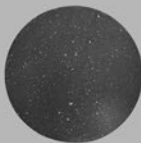

Grey WD

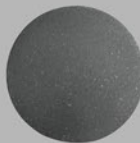

Brown WD



Beige BD



White



Pastel Drains

Peach



Banane



Mint



Smoke Blue

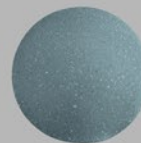

Azul

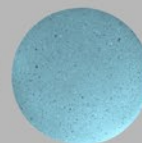

Flamingo



Terracotta

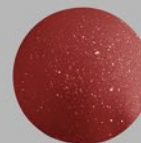

Terrazzo Drains

Terra White



Terra Black

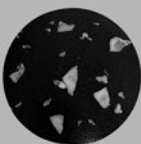

CIVIL ENGINEERING SERVICE LABORATORIES

مختبرات الهندسة المدنية

CERTIFICATE OF TEST

Requested by **Stonium
LEBANON** Date **08/09/2022**
Your Ref.
Our Ref. **R- 31023**

Nature of Test

Tests on "Ultra High Performance Concrete" sample.

1. Absorption Capacity and Density ASTM C 97			
Sample Designation	Dimension cm	Absorption Capacity Percent by Weight	Density Kg/m ³ (Pcf)
Ultra High Performance Concrete	5.0x5.0x5.0	0.40	2384 (148.82)
2. Flexural Strength ASTM C 880			
Sample Designation	Flexural Strength MPa (Psi)		
Dimension Ultra High Performance Concrete	12.6 (1827.4)		
3. Compressive Strength C 170			
Sample Designation	Dimension cm	Compressive Strength Mpa (Psi)	
Ultra High Performance Concrete	5.0x5.0x5.0	60.0 (8702.0)	
4. Abrasion Resistance Using Tinius Olsen Wearometer C.D.R.			
Sample Designation	Loss in Thickness After 1000 Revolutions mm (inch)		
Ultra High Performance Concrete	0.25 (0.01)		

for *Salah Sadek*
Salah Sadek, Ph.D.
Professor of Civil & Environmental Engineering



Our concrete has been tested in the American University of Beirut (AUB) to ensure and certify that our products are heavy duty and meet all international standards.

Using Ultra High Performance Concrete (UHPC) in all we produce, Stonium's selection has a very high-density and surpasses all laboratory testing, with very minimal absorption and pores that are unlike any other concrete products on the market.

ASTM SHEET
American University of Beirut (AUB)



STONIUM
SIMPLE UPGRADES



STONIUM
SIMPLE UPGRADES



STONIUM
SIMPLE UPGRADES



Industrial Zone, Zouk Mosbeh Kesserwan, Lebanon

Tel : +961 9 217 983/4 | Mobile: +961 76 510 131

Email: sales@stonium.com.lb

www.stonium.com.lb

 [stonium.lb](https://www.instagram.com/stonium.lb)  [stonium.lb](https://www.facebook.com/stonium.lb)  [stonium](https://www.linkedin.com/company/stonium)