



**STONIUM**

S I M P L E U P G R A D E S





## About Us.



If you're a business owner or a homeowner looking to upgrade the interior facilities of your space, then Stonium is exactly what you need to elevate the look and feel of any kitchen or bathroom.

Founded in 2014 by brothers Jad and Charbel Rizk, the company offers a wide variety of high-end, durable, quality products made from US and Russian technologies and materials, in order to keep you up with the latest trend within the right budget.

### Team Work

We provide timely delivery for all your needs and a dedicated customer service team for support, along with frequent updates to our products by providing you with the latest carefully-selected designs, each created to meet the needs of your brand or home.

And keeping in line with the latest industry trends, we are always on the lookout for the newest models, colors, designs, and fashion needs to match your very own.

STONIUM

“

We make some tests stand out to emphasize the big point.

## Our Concrete

Using Ultra High Performance Concrete (UHPC) in all we produce, Stonium's selection has a very high-density and surpasses all laboratory testing, with very minimal pores that are unlike any other concrete on the market.

Due to years of collective experience, research, and experimentation, Stonium has created a line of products that boast absorption levels nearing zero and ultra-reliability for long-term use.



## The Founders.

Meet Charbel Rizk, the ultimate perfectionist, and technical mind behind Stonium's products. With a love for production,

organization, and a total eye for all things involving attention to detail, Charbel never settles for less than absolute perfection.

With a degree in Industrial Engineering from the Lebanese American University (LAU), he went on to study concrete technology in the United States and Russia at two highly esteemed and reputable institutions.

Taking over the family business in the production of natural stone manufacturing since 2009, he used both his experience and knowledge regarding stone and concrete technology to create the Stonium formula.



Charbel Rizk

STONIUM



Jad Rizk

## The Founders.

We've met the technical side of the duo with Charbel Rizk, and here we come to the strategic side with his brother, Jad Rizk.

As a business marketing graduate from Notre Dame University (NDU), Jad seeks to find new solutions to everyday problems in the industry.

His many years of experience studying natural stones – and the designs that suit them best – have helped him in matching the right colors and textures to essential daily household products that best suit the needs of not just the market itself, but clients of all kinds.

Along with his brother Charbel, Jad took a leadership role in the family business since 2010 through the managing, marketing, and sales of Stonium, much in part due to his education in Russia regarding concrete trends and technologies.



**SURFACES**

2D Series

---

Technical Sheets & Projects

---



**TRI**

**STONUM**

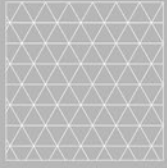

# Surfaces

## Tri

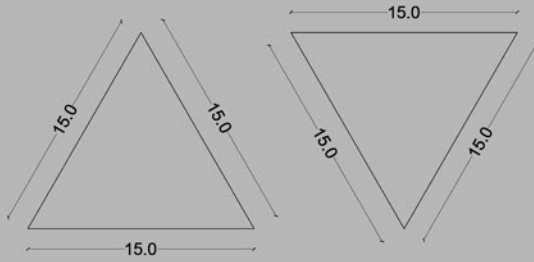

- ✓ The equilateral triangle-shaped tile Tri is modern and sleek. If necessary, it is made to also go well with our Rombo and Hexa tiles, allowing you to mix and combine them to make a distinctive and striking pattern.
- ✓ Handcrafted with sustainable and eco-friendly material.
- ✓  $1\text{m}^2 \approx 102$  pieces
- ✓ 1 piece  $\approx 0.43$  kg



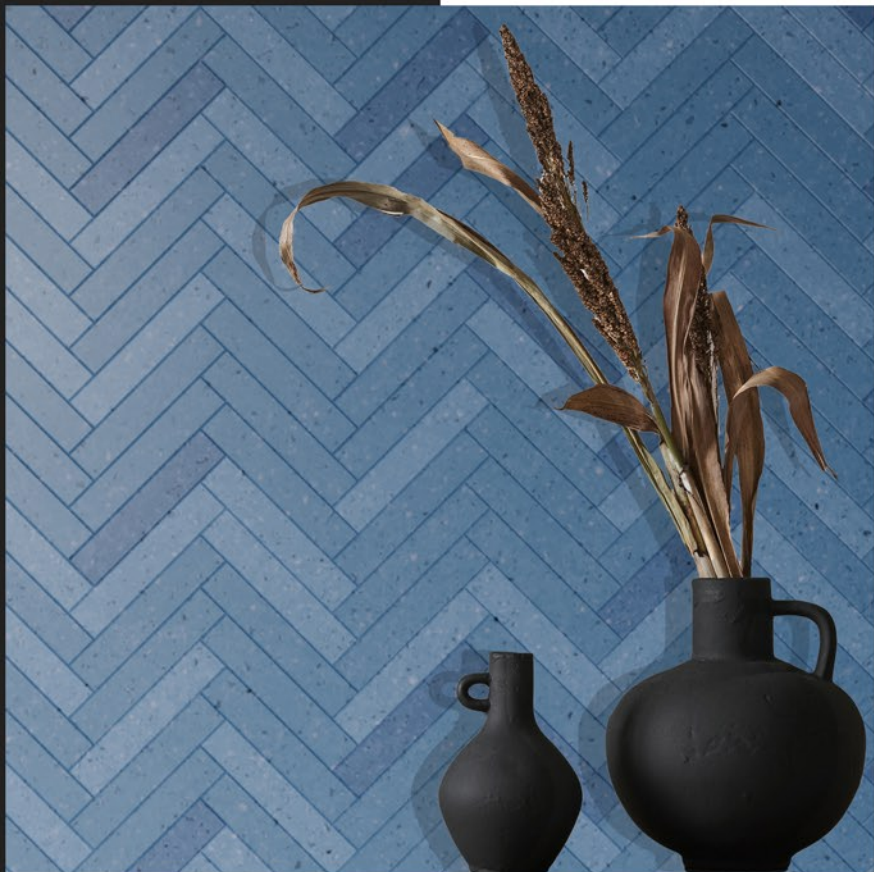

# CHEVRON

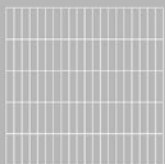
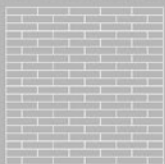

# Surfaces

## Chevron



- ✓ Discover Chevron's refined elegance. With its classic pattern and alluring design, this French-style tile, never gets old and elegantly alters the atmosphere.
- ✓ Handcrafted with sustainable and eco-friendly material.
- ✓  $1\text{m}^2 \approx 100$  pieces
- ✓ 1 piece  $\approx 0.44$  kg





## **FISH SCALE**

STONUM



# Surfaces

## Fish

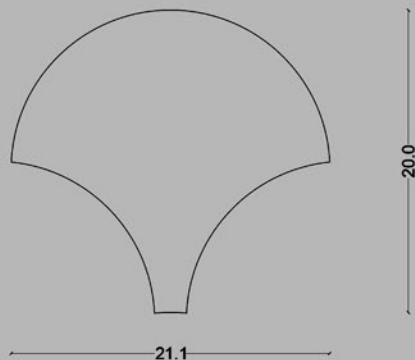

- ✓ "The Fish Tile." This distinctive form, which resembles fish scales, gives the room enough texture, makes your living space extremely ideal, and keeps it always active.
- ✓ Handcrafted with sustainable and eco-friendly material.
- ✓  $1\text{m}^2 \approx 43$  pieces
- ✓ 1 piece  $\approx 0.95$  kg





## ROM

STONICUM

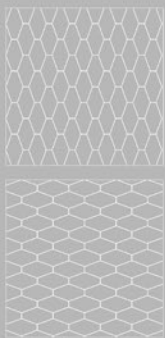

# Surfaces

## Rom

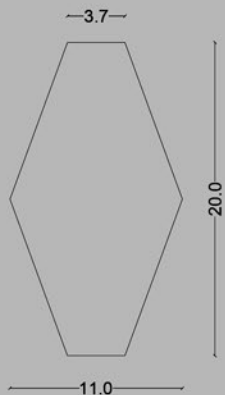

- ✓ Our contemporary honeycomb-inspired, rhombus-shaped Rom tile has cut heads. It gives a sense of contemporary design and works best in bathrooms and kitchens.
- ✓ Handcrafted with sustainable and eco-friendly material.
- ✓  $1\text{ m}^2 \approx 68$  pieces
- ✓ 1 piece  $\approx 0.65$  kg





**TAJ**

**STONIUM**

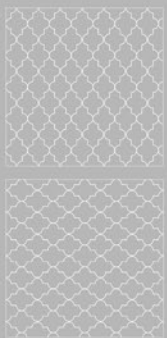

# Surfaces

## Taj

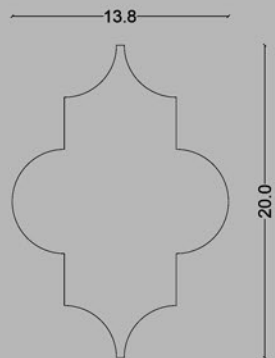

- ✓ The Taj, another Arabian tile from Stonium, raises the bar for your walls with its magnificent design. Enjoy the splendor of the Middle East in the comfort of your own home.
- ✓ Handcrafted with sustainable and eco-friendly material.
- ✓  $1\text{ m}^2 \approx 70$  pieces
- ✓ 1 piece  $\approx 0.62$  kg





**ROMBO**

STONUM

# Surfaces

## Rombo

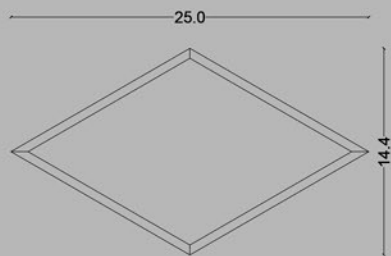
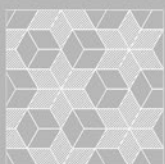
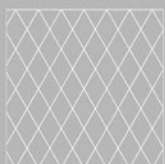
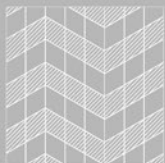
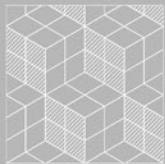
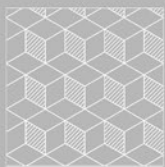

✓ Our concrete rhombus is displayed here, developed for movable installations that yield unusual patterns. The wall looks modern and stylish due to its ingenious design, which provides a wide range of options. That's a simple and creative tile, made to enhance your decor.

✓ Handcrafted with sustainable and eco-friendly material.

✓  $1\text{m}^2 \approx 55$  pieces

✓ 1 piece  $\approx 0.77$  kg



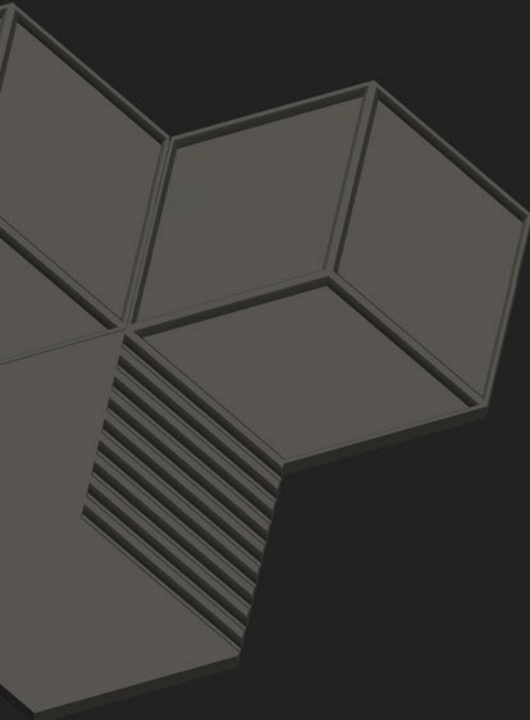

**SURFACES**

3D Series

---

Technical Sheets & Projects

---



# HEXA

STONUM



# Surfaces

## Hexa

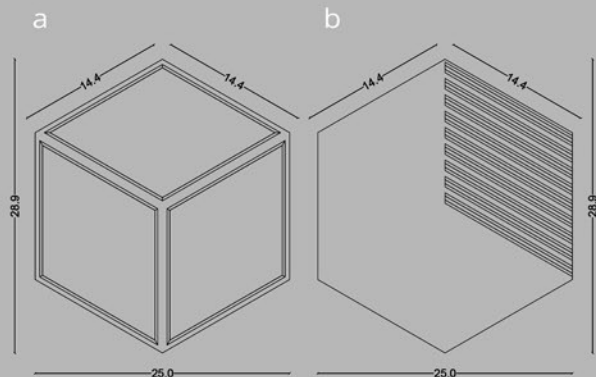

- ✓ Presenting our avant-garde concrete hexagon tile! Its clever design offers countless mounting options, producing distinctive and eye-catching patterns. With this adaptable and visually appealing tile, your walls can now make a strong statement.
- ✓ Handcrafted with sustainable and eco-friendly material.
- ✓  $1\text{m}^2 \approx 18$  pieces
- ✓ a 1 piece  $\approx 1.33$  kg  
b 1 piece  $\approx 2.38$  kg





# LEAF

STONICUM

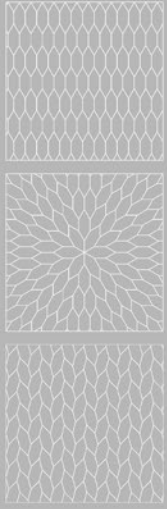

# Surfaces

## Leaf

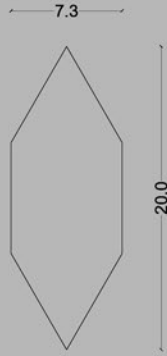

- ✓ The 3D Leaf - an ultra-modern tile with a 3D leaf shape that creates stunning shades when light passes through. Versatile installation options make it perfect for any space.
- ✓ Handcrafted with sustainable and eco-friendly material.
- ✓  $1\text{m}^2 \approx 100$  pieces
- ✓ 1 piece  $\approx 0.33$  kg





## DRAGON SCALE

STONICUM

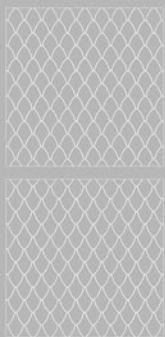

# Surfaces

## Dragon Scale

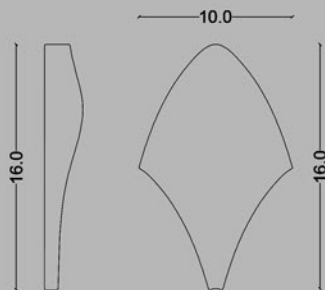

- ✓ For contemporary interiors looking for a bit of daring, then our Dragon Skin is certainly your tile. This 3D pattern is a beautiful imitation of dragon skin that gives it a distinctive textured appearance.
- ✓ Handcrafted with sustainable and eco-friendly material.
- ✓  $1\text{m}^2 \approx 115$  pieces
- ✓ 1 piece  $\approx 0.36$  kg





# ARABIKA

STONUM

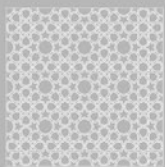

# Surfaces

## Arabika

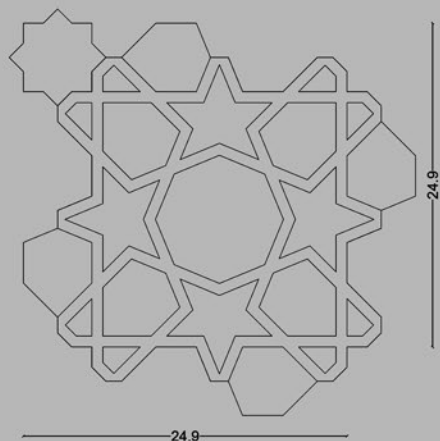

- ✓ With our gorgeous Arabika concrete wall tiles, you can bring the charm of traditional Arabian spaces on your walls. These tiles are excellent for bringing a little class, refinement, and a touch of history to your space. Always thanks to Stonium 3D jointless technology.
- ✓ Handcrafted with sustainable and eco-friendly material.
- ✓  $1\text{m}^2 \approx 16$  pieces
- ✓ 1 piece  $\approx 1.77$  kg



STONIUM

# COLOR PALETTE.

All the colors in the palette are integral within the concrete mix, and we will always be releasing new colors. Subscribe to our newsletter to stay updated with our latest additions.



Earthtone  
Series



Pastel  
Series

## Earthtone Series

Black WD



D Grey WD

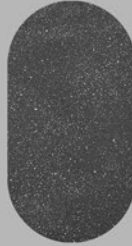

Grey WD

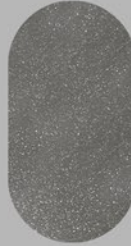

Brown WD



Beige BD



White



## Pastel Series

Peach



Banane



Mint



Smoke Blue



Azul



Flamingo



Terracotta

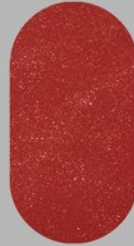

CIVIL ENGINEERING SERVICE LABORATORIES

مختبرات الهندسة المدنية

CERTIFICATE OF TEST

Requested by **Stonium  
LEBANON** Date **08/09/2022**  
Your Ref.  
Our Ref. **R- 31023**

Nature of Test

Tests on "Ultra High Performance Concrete" sample.

1. Absorption Capacity and Density ASTM C 97			
Sample Designation	Dimension cm	Absorption Capacity Percent by Weight	Density Kg/m <sup>3</sup> (Pcf)
Ultra High Performance Concrete	5.0x5.0x5.0	0.40	2384 (148.82)
2. Flexural Strength ASTM C 880			
Sample Designation	Flexural Strength MPa (Psi)		
Dimension Ultra High Performance Concrete	12.6 (1827.4)		
3. Compressive Strength C 170			
Sample Designation	Dimension cm	Compressive Strength Mpa (Psi)	
Ultra High Performance Concrete	5.0x5.0x5.0	60.0 (8702.0)	
4. Abrasion Resistance Using Tinius Olsen Wearometer C.D.R.			
Sample Designation	Loss in Thickness After 1000 Revolutions mm (inch)		
Ultra High Performance Concrete	0.25 (0.01)		

for *Salah Sadek*  
Salah Sadek, Ph.D.  
Professor of Civil & Environmental Engineering



Our concrete has been tested in the American University of Beirut (AUB) to ensure and certify that our products are heavy duty and meet all international standards.

Using Ultra High Performance Concrete (UHPC) in all we produce, Stonium's selection has a very high-density and surpasses all laboratory testing, with very minimal absorption and pores that are unlike any other concrete products on the market.

**ASTM SHEET**  
American University of Beirut (AUB)

Industrial Zone, Zouk Mosbeh Kesserwan, Lebanon

Tel : +961 9 217 983/4 | Mobile: +961 76 510 131

Email: [sales@stonium.com.lb](mailto:sales@stonium.com.lb)

[www.stonium.com.lb](http://www.stonium.com.lb)

 [stonium.lb](https://www.instagram.com/stonium.lb)  [stonium.lb](https://www.facebook.com/stonium.lb)  [stonium](https://www.linkedin.com/company/stonium)